



STEINEL DCS™ Applications for Contractors

SHAWN STEFANYAK

STEINEL Digital Control Solution™

Innovative Technology



- Smarter coverage pattern covers square rooms
- 4800 detection zones (IR Quattro HD sensor)
- Rooms require fewer sensors (Up to 4,200 sq ft of coverage per sensor)
- Commissioning apps available for Apple and Android products
- Out of the box functionality and code compliance

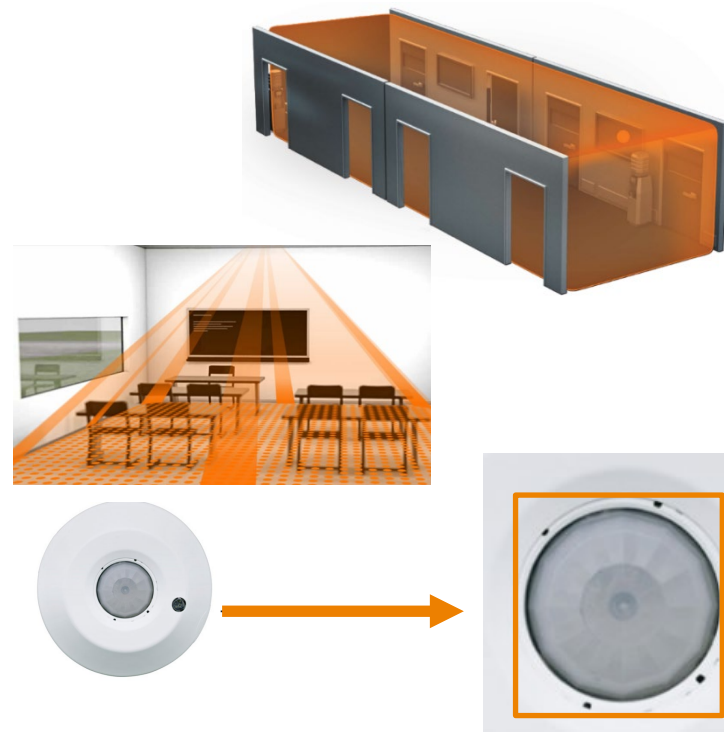

Traditional coverage

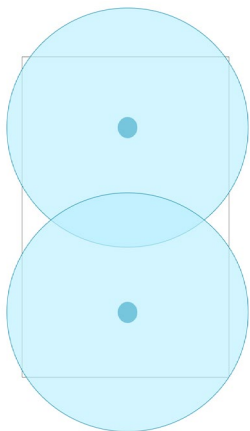

Steinel coverage

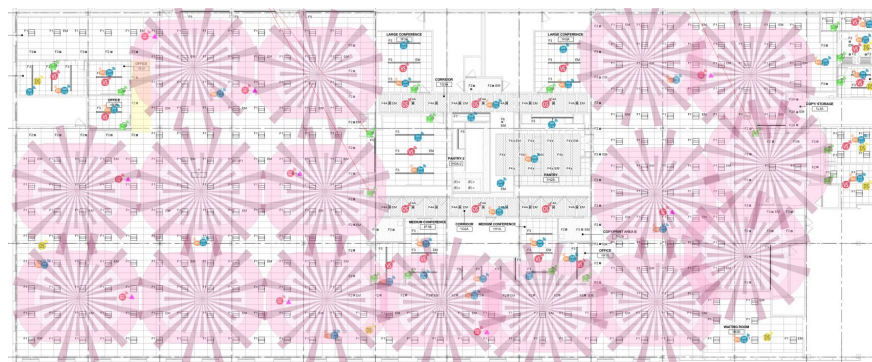
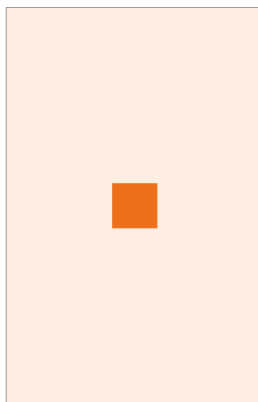

STEINEL Digital Control Solution™

Easy to Install.



1. Line voltage wires
2. Low voltage door latch
3. Test buttons
4. Low voltage terminals
5. ½" threaded nipple
6. Two lock nuts
7. Led
8. Reset button
9. RJ45 BACnet port
10. Low voltage wires

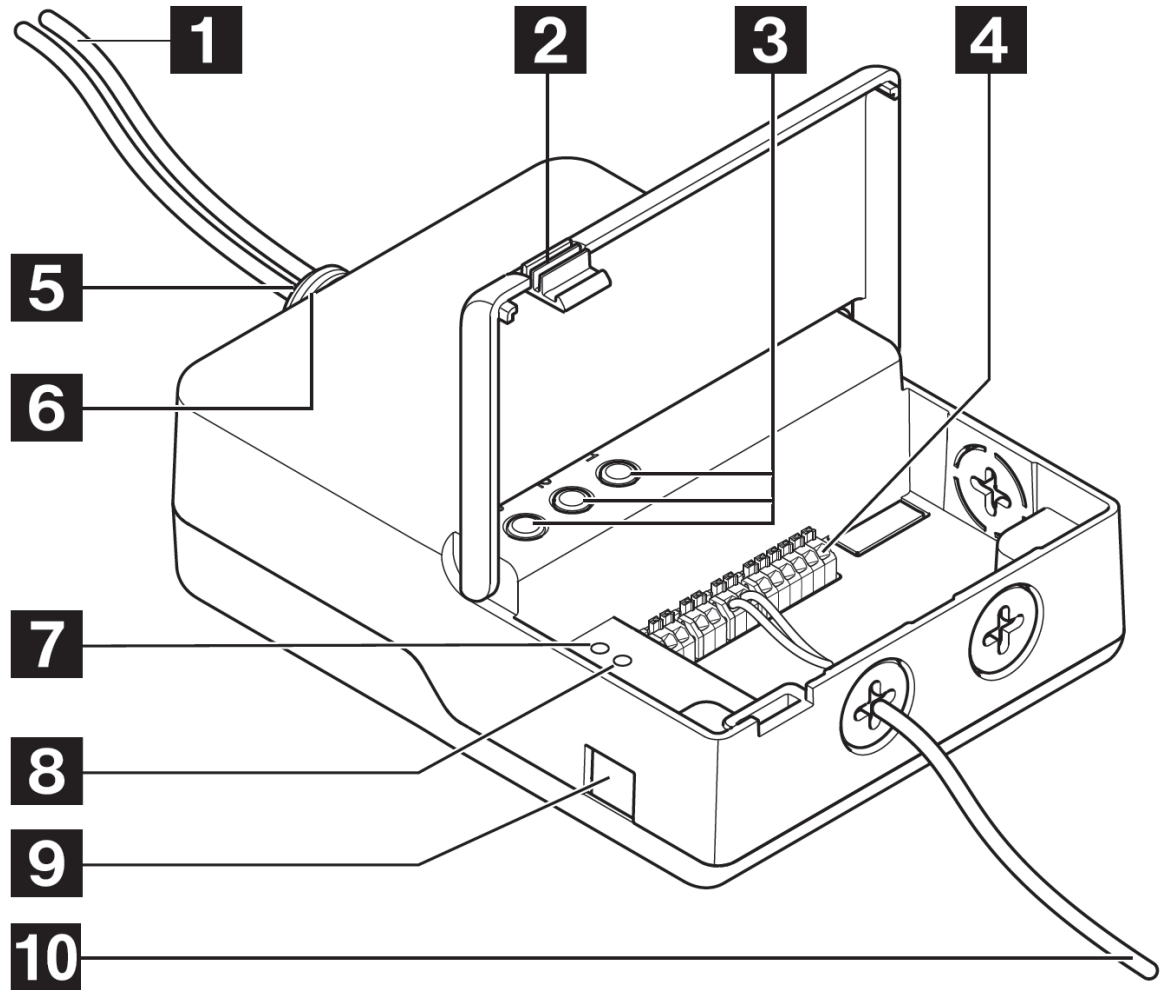

STEINEL Digital Control Solution™

Best Applications: Contactor / Wall Acne

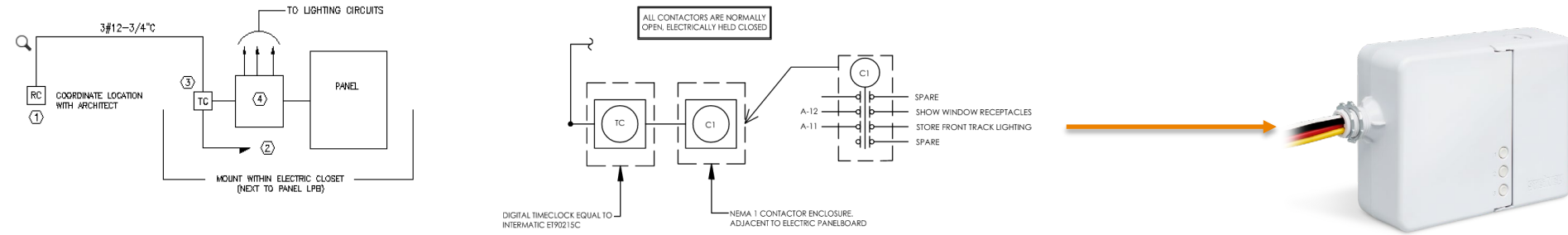

No tedious wiring from timeclock to contactor to lighting load. DCS is a LOCAL controller with timeclock built in.

No more "wall acne" and having to homerun luminaire cable back to switchbank. DCS switchlegs and dimming can be local to fixtures, and 12/2 can run up to 1000' to a DCS switchbank.

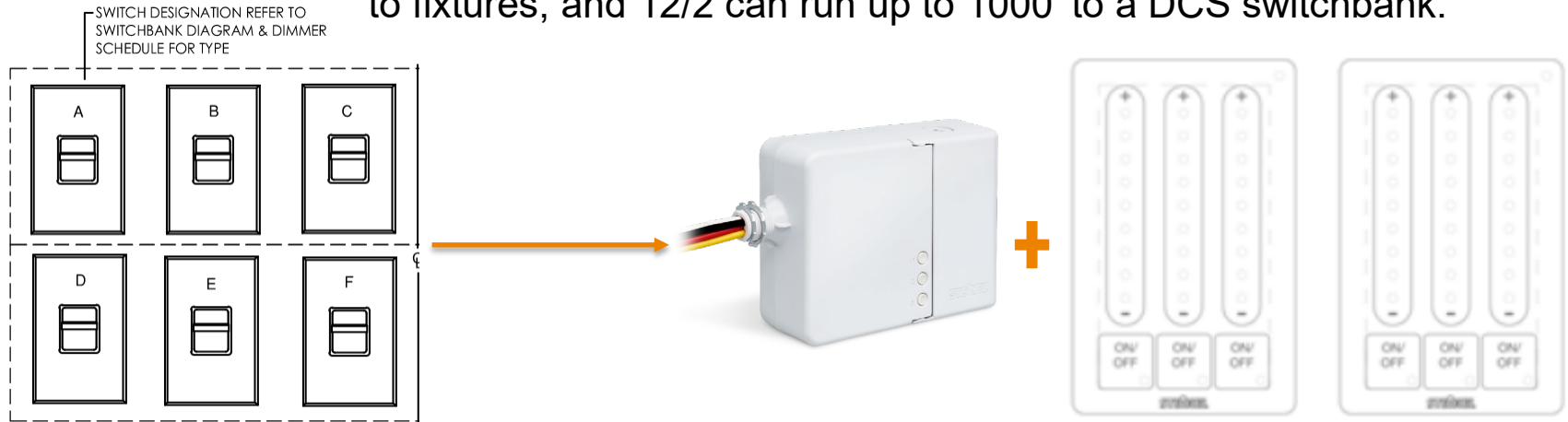

STEINEL Digital Control Solution™

Best Applications: Exterior Lighting



1. Astronomic Timeclock is built in to the DCS and allows for sunrise/sunset operation for all exterior lighting. Many cases this allows exclusion of exterior photocells.
2. The DCS has (3) 20A relays, which can control up to three zones of exterior lighting.
3. Internal timeclock can control signage lighting, to come during operational hour.

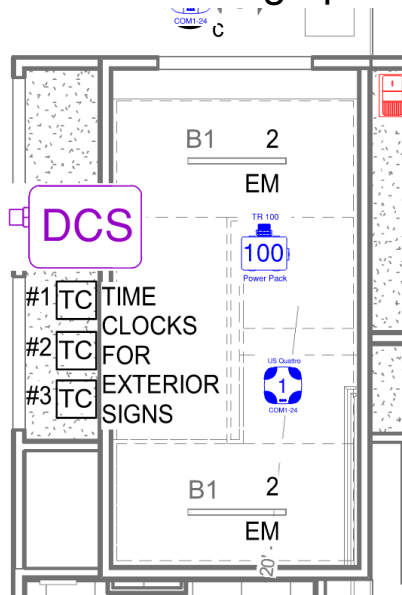

STEINEL Digital Control Solution™

Best Applications: Plug and Play

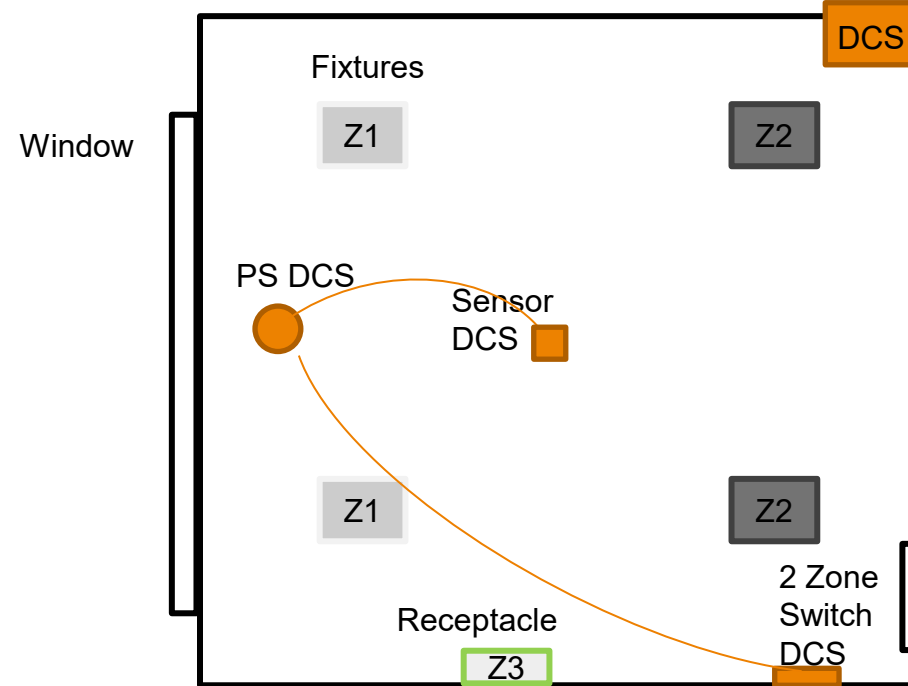
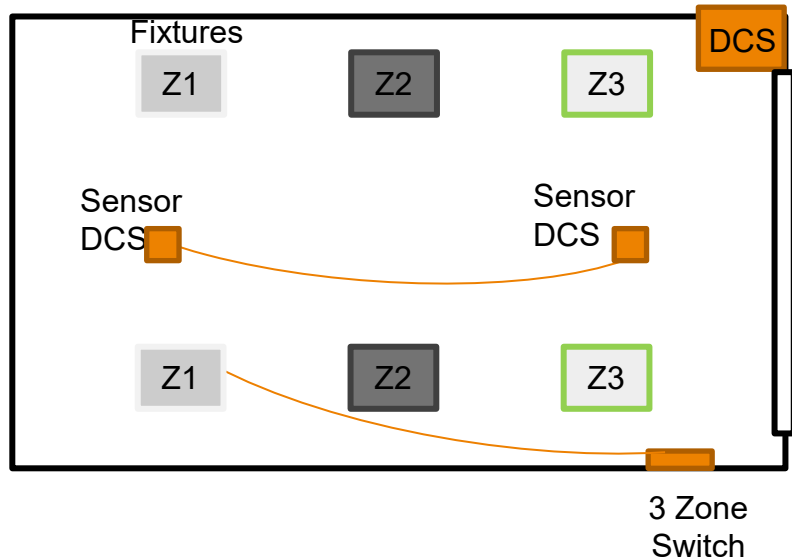

- DCS can be plug and play and **CODE COMPLIANT** operational without and commissioning required.

The default scene consist of the following settings:

- Sensor settings:
 - Time Delay: 20 min
 - Partial ON in 50 % all loads

STEINEL Digital Control Solution™

Best Applications: Contractor Commissioning

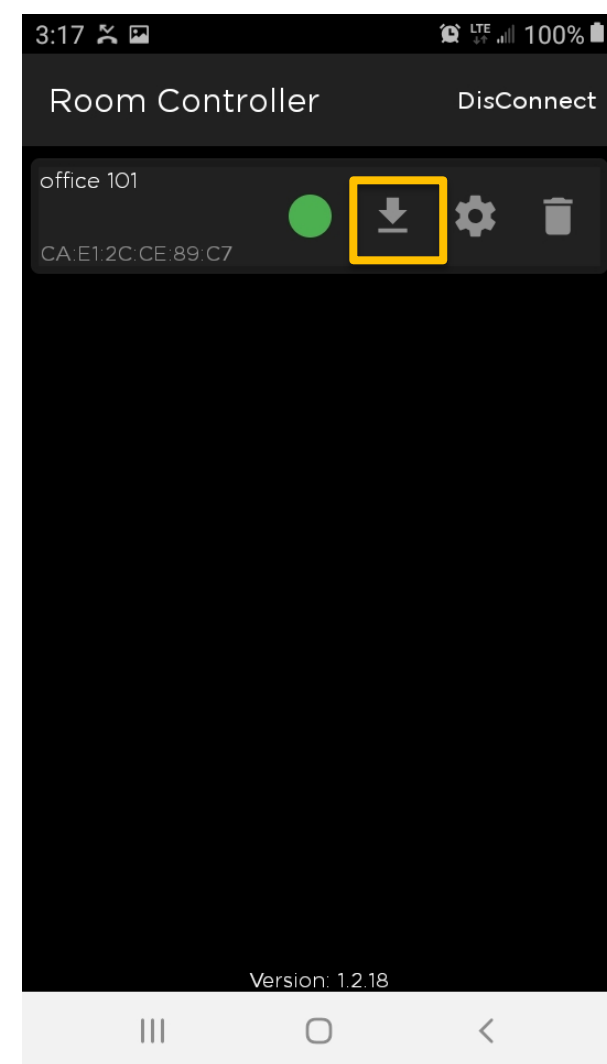
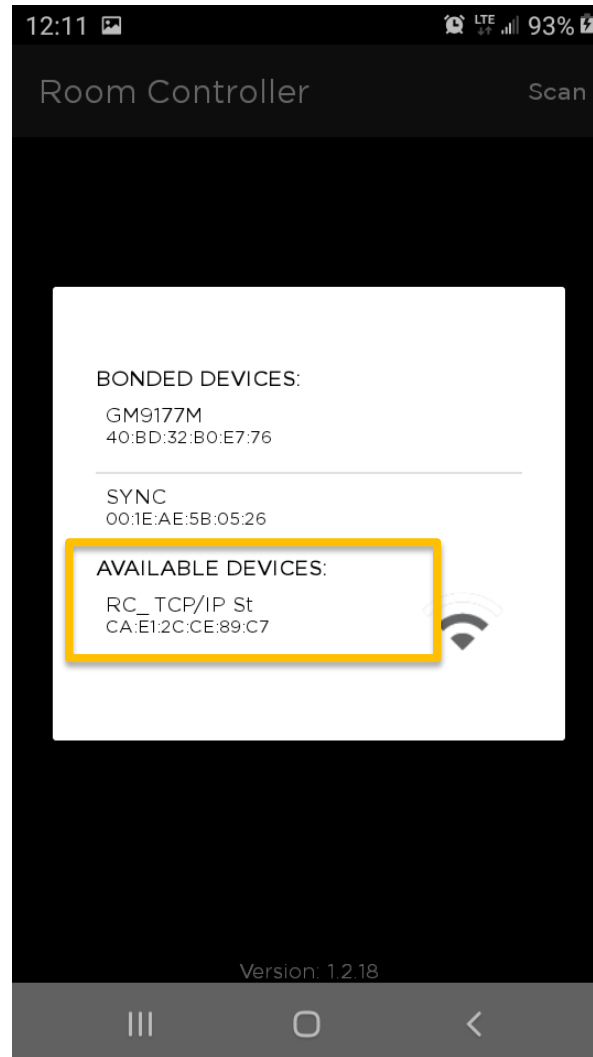
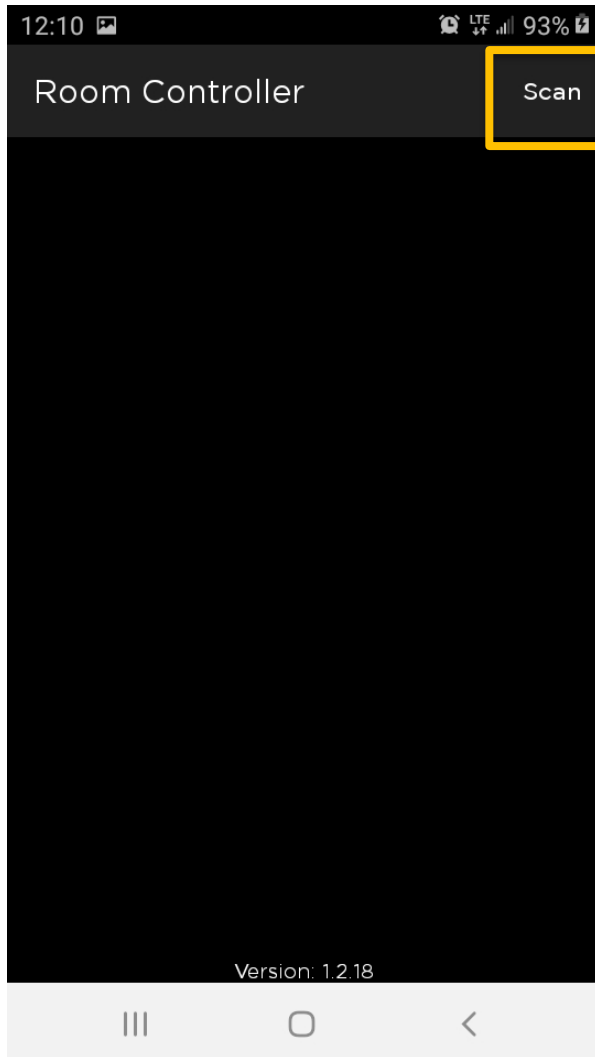

STEINEL Digital Control Solution™

Best Applications: Contractor Commissioning

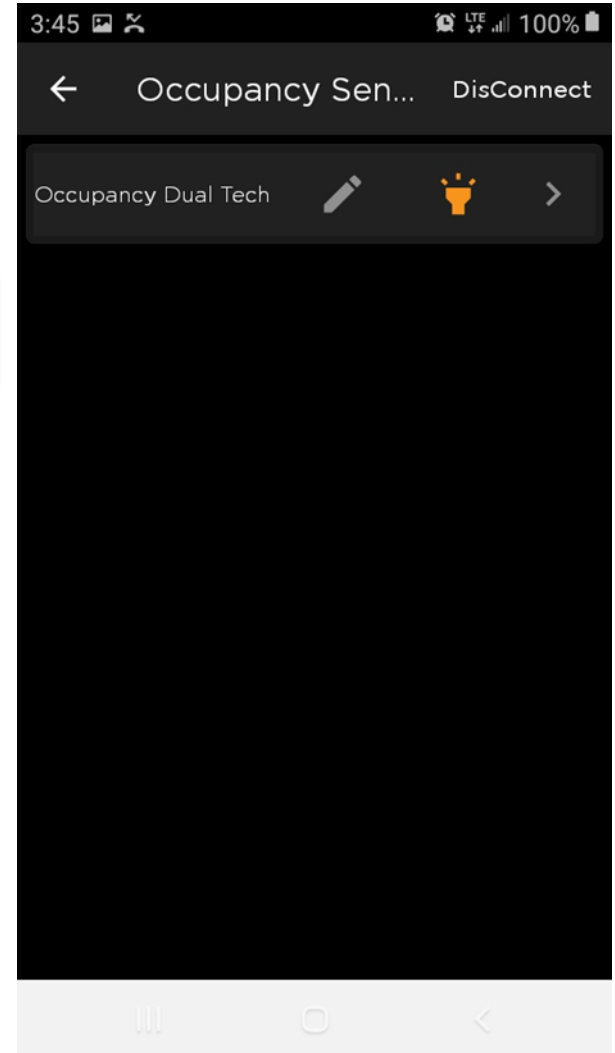
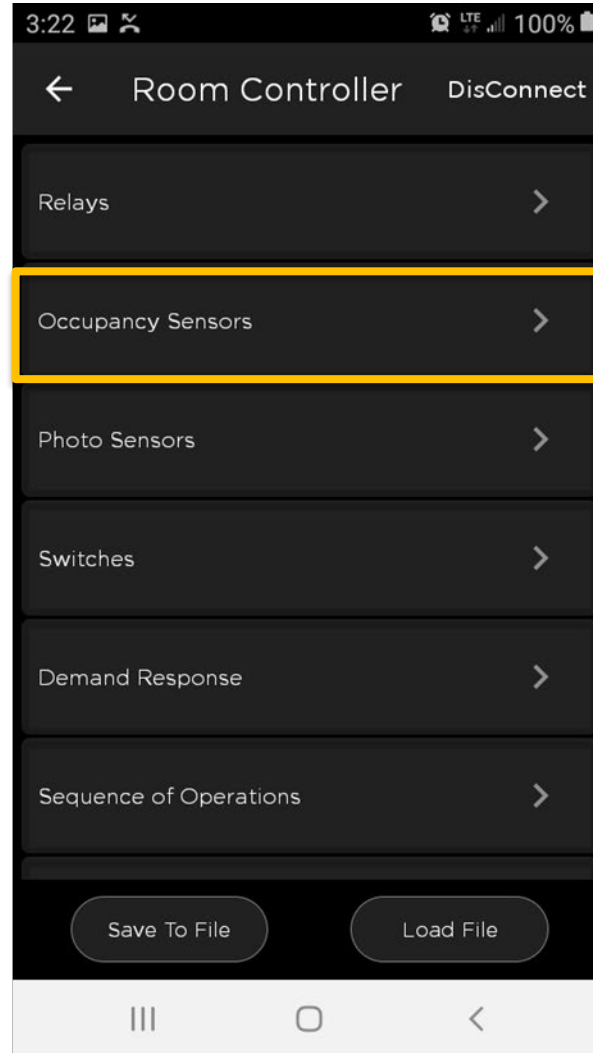
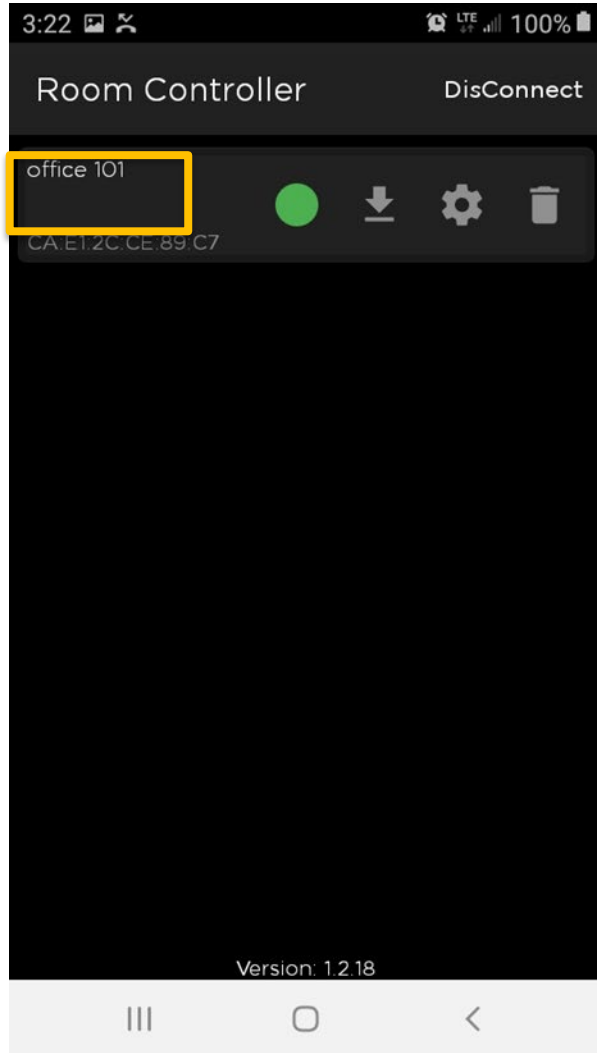

STEINEL Digital Control Solution™

Best Applications: Contractor Commissioning

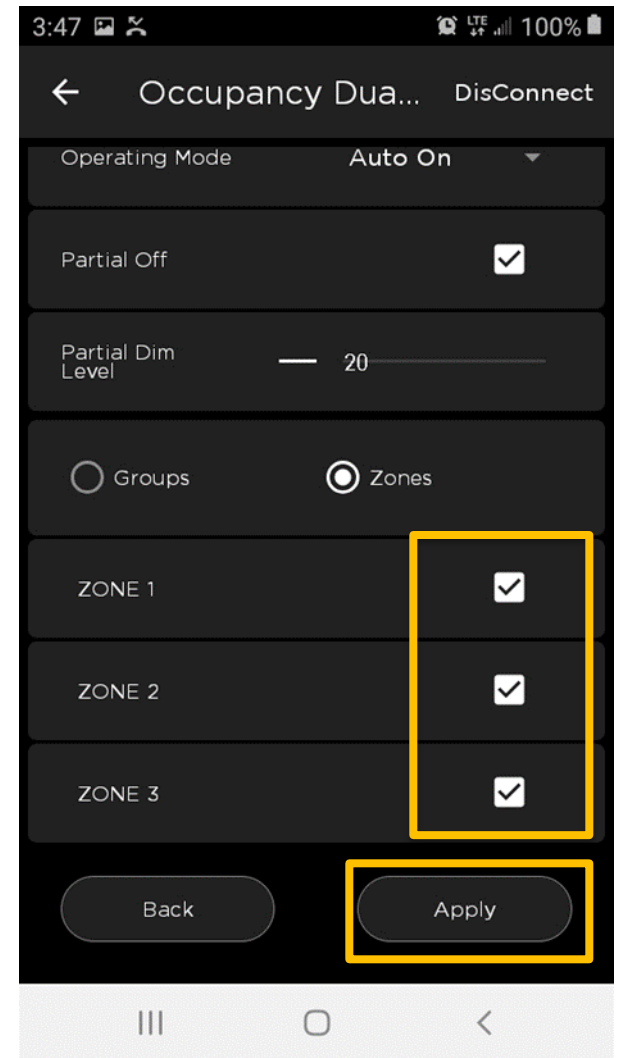
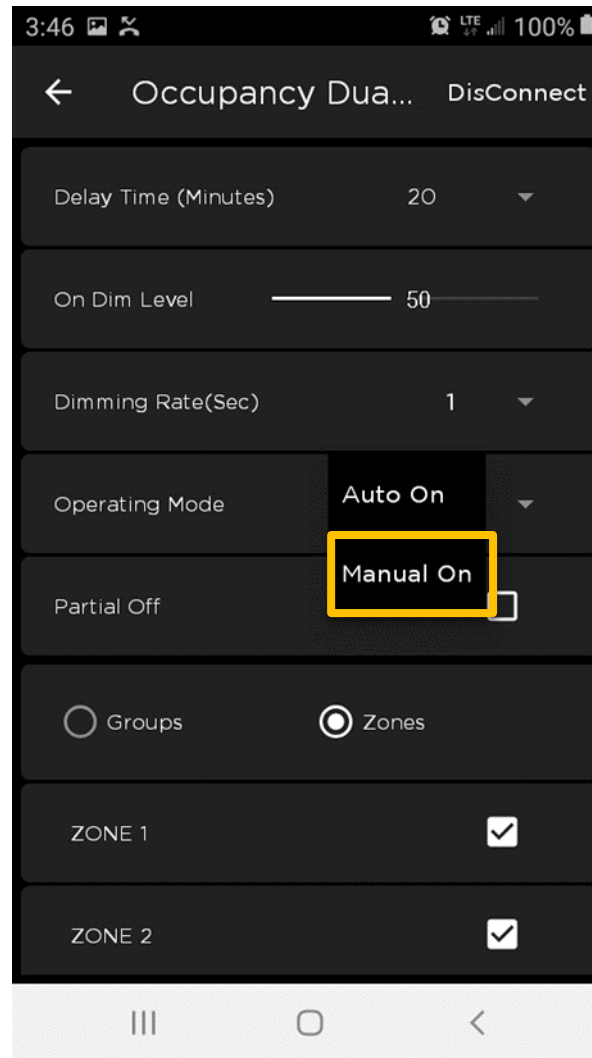
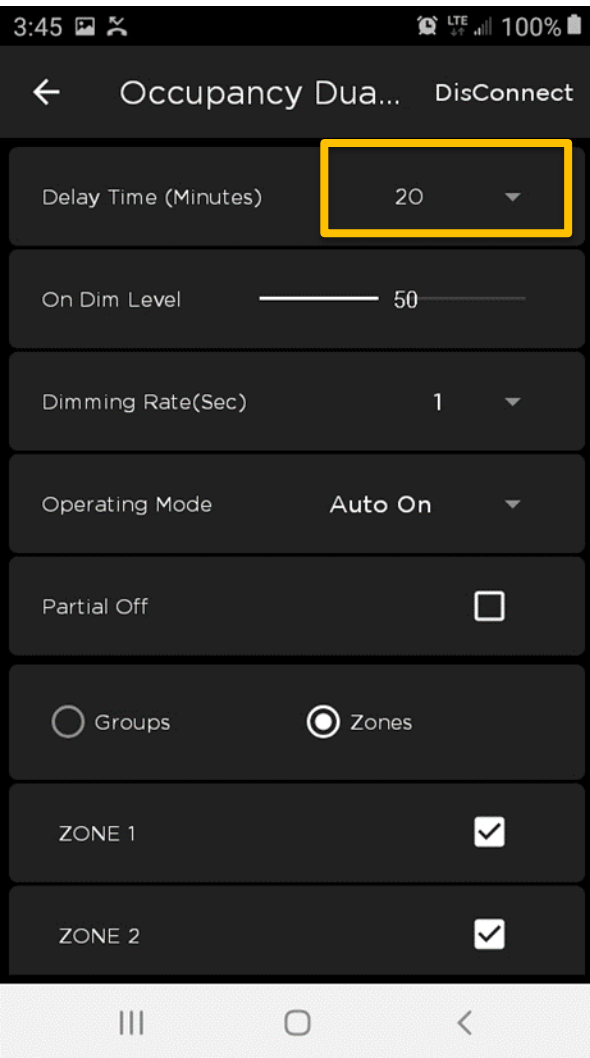

DCS™ answers the demand for a **COST-EFFECTIVE** digital controller that **MAXIMIZES** energy savings.

Everything you need, code-compliant out of the box.

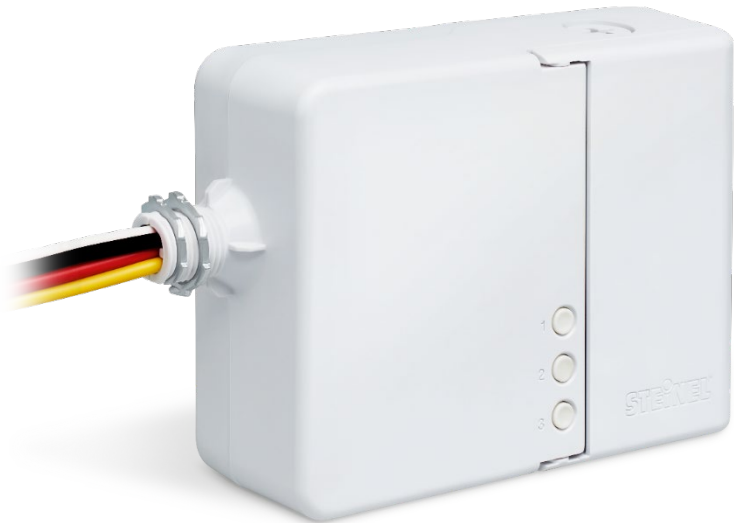

- Digital bus for sensors, switches, photo cells
- Wireless programming
- Predefined (out of the box) & custom use case generation
- Preset or custom scenes
- 3 independent 20A relays
- Current monitoring per relay
- 3 independent 0-10v dimming zones
- Receptacle control
- Multi-zone daylighting
- Min. & max. dimming levels
- Hold off / Force off photo sensor functions
- Partial on & off
- Demand response
- Astronomic and time clock functions
- Wireless BLE mesh interconnectivity
- BMS integration via BACnet * **DCS Connect**

Examples of Successful DCS Projects Complete

Commercial Office Space in Virginia

- 33 DCS Units
- 59 DT Quattro Sensors
- 40 Momentary Switches
- Misc. other devices
- Project Installed and Commissioned

Commercial Office Space in Maryland

- 20 DCS Units
- 47 DT Quattro Sensors
- 48 Momentary Switches
- Misc. other devices
- Project Installed and Commissioned

Examples of DCS Projects Awaiting Installation

Commercial Office Space in Maryland

- 66 DCS Units
- 120 DT Quattro Sensors
- 80 DCS Wall Switches
- Misc. other devices
- Project shipped, awaiting install

Call Center in Missouri

- 18 DCS Units
- 24 DT Quattro Sensors
- 60 DCS Wall Switches
- Misc. other devices
- Project shipped, awaiting install

STEINEL Digital Control Solution™

Quality Products. Quality Service.

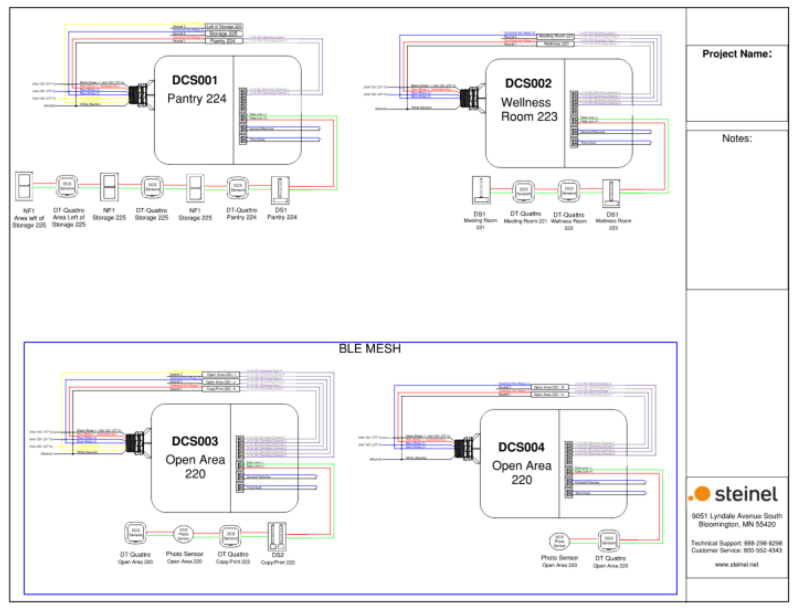

**FULL SUBMITTAL PACKAGES FOR
EASE OF INSTALLATION**

ON-SITE OR VIRTUAL PRE-WIRE VISITS

“The Steinel DCS controllers, sensors and switches all worked as advertised. The Steinel Sales Manager was a huge help throughout the entire process. He was always available via phone/email, and came out for a pre-wiring walk through to ensure all questions and concerns were addressed up front. Final commissioning was a breeze, and the whole floor was programmed in less than two days.”

– RTL ELECTRIC, CHANTILLY VA

1. Place Order by 1 pm CST for **Same Day Shipping**
2. Quick Quote and **FREE Layouts**, 24-48 Hours
3. Significant **Cost Savings** on Digital Replacement
4. Wire Diagrams on the Sensors
5. Sensors Can Be Changed in field with No Re-wiring Required
6. No Waiting, **Easy and Fast Commissioning**
7. Out-of-the-Box Functionality
8. Photocells included in Control Pro Series (True Daylight Harvesting)
9. Larger Coverage Pattern = Less Sensors Required = Less Wiring = Less Labor = **SAVINGS**

We Can Do More For Less

Contact Your Regional Sales Manager Today!

STEINEL Digital Control Solution™

Easy to Install. Easy to Program.



Digital Done Better

Questions about our solutions?

tech@steinel.net

888.298.8298

Need layouts for your project?

Contact our tech team or your
Regional Sales Manager.

Need to connect with our sales team?

sales@steinel.net

800.852.4343

QUALITY
PRODUCTS.
QUALITY SERVICE.

